



3D SIMO
MINI MANUAL

For more information on your device, please
visit our website at:

www.3dsimo.com

3D SIMO MINI

Instructions for use



 3D SIMO

Content:

1. Introduction of 3Dsimo mini
2. The content of the packaged product
3. Basic description of the 3Dsimo mini
4. Mobile APP
5. Procedure for operating and replacing
6. 3Dsimo mini extensions
7. Maintenance
8. Warning
9. Specifications
10. Certification
11. Claims

of 3Dsimo mini

You have got your hands on a pocket workshop. This is the 3Dsimo mini, which includes replaceable extensions (3D drawing, welding, cutting, burning). Each extension has logic for its detection and a setup of all parameters so that you only need to insert the extension.

The 3Dsimo mini communicates with a mobile device using its own APP. It offers a lot of instructional videos, templates, but also the option of setting custom material profiles. It's OK if you don't have a smartphone; the 3Dsimo mini is equipped with an LED display that shines through the plastic wall.

All the information needed to operate this device can be found on the following pages.



Strong recommendation from the manufacturer:

Before using the 3Dsimo mini, please read the instructions carefully and pay attention to warnings.

If you need inspiration or are having issues,
visit our website:

www.3dsimo.com

2. The content of the

packaged product

The packaged product includes the following components:

- 1 mini 3Dsimo with 3D drawing extension
- 1 connecting extension
- 1 burning extension
- 1 cutting extension
- 1 Adapter + USB cable
- 1 15m of the drawing filament
- 1 agent for removing a jammed filament
- 3 Resistance wire

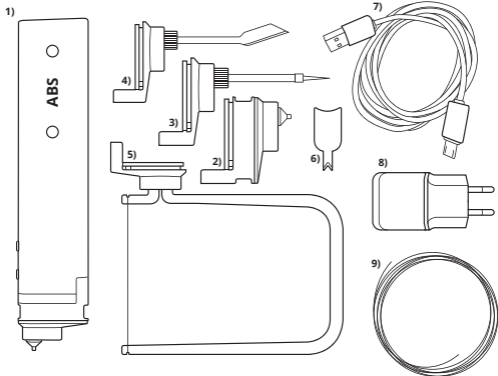

3. Basic description

of 3dsimo mini

1. Material/temperature selection buttons (depending on the chosen extension)
2. The buttons used for inserting / ejecting / heating (depending on the chosen extension)
3. USB power connector
4. Magnetic contacts for attaching accessories
5. Contact for power pack and other accessories
6. Opening for cutting jammed filament
7. Plug-in mechanism

3.

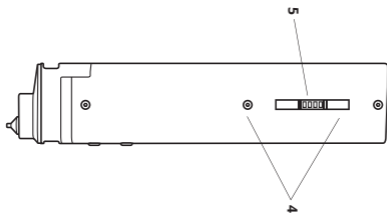
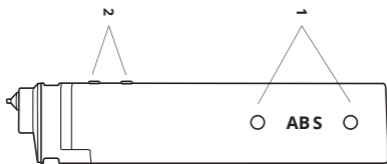

Mobile App

The Mobile App can be downloaded for Android, IOS, Win.



and replacing extensions with the 3Dsimo mini

1. After connecting the adapter into a wall outlet and the USB connector, the text saying 3D pen will be displayed on the LED display and then the specification of what extension you should insert in the 3Dsimo mini. If you do not have any extension inserted, the text UNSPECIFIED will appear.
2. Always insert the extension to the stop (Fig. 4).  (The extension is not recognized when not inserted to the stop!)

5.

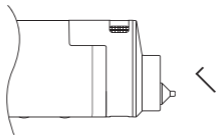
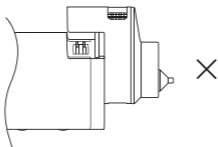
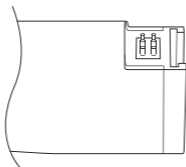

3. **3D DRAWING**

After inserting this extension, the text 3D tool appears, followed by the choice of material. After selecting the desired material, the text HEATING is displayed. After reaching the appropriate temperature (2-3min), READY is displayed. Now the feeder mechanism is already activated and you can insert the filament of the 3Dsimo mini (Note: Always insert a straightened filament, which has a blunt end as in Fig. 5).

5.

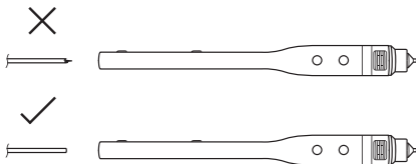

3. **A) INSERTING THE FILAMENT:**

insert the filament into the rear opening and press the forward button (Figure No. 6); at the same time you need to gently push the string to get it into the feed mechanism. Then it takes approximately 10 seconds before the wire reaches the nozzle and the material starts flowing from the 3Dsimo mini.

5.

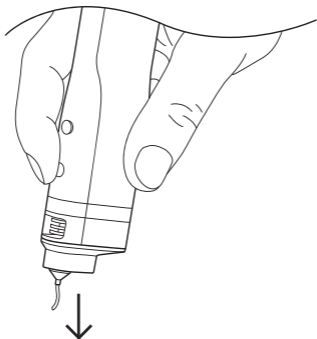

3. **B) SPECIAL FEATURE**

After pressing both buttons simultaneously for at least 2-3 sec., continuous extrusion will be activated

(Fig. no. 7). To disable this feature, press any front button.

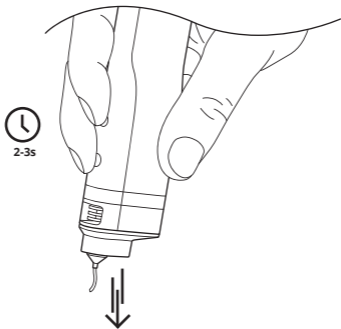

3. **C) REPLACEMENT AND REMOVAL OF THE FILAMENT:**

Pressing the button for reverse running and hold it until the entire string comes out. Then, remove the string and insert another one with a flat end (Fig. No. 8). (Remove the filament only after warming up the 3Dsimo mini and activating the feed mechanism!)



4. **EXTENSIONS FOR WELDING, CUTTING AND BURNING:**

After inserting any extension, you'll see its name on the display and then the temperature indicated in percentages. 100% corresponds to 480°C.

For preheating it is required to hold the front button. To enable continuous preheating, press both front buttons simultaneously for at least 2-3 sec. (Figure No. 7).

5. **REPLACEMENT OF TIPS AND EXTENSIONS FOR BURNING AND CUTTING:**

For proper replacement, refer to Figure No 9. It is always necessary to carefully tighten everything! (Replacement of tips can only be carried out after cooling!)

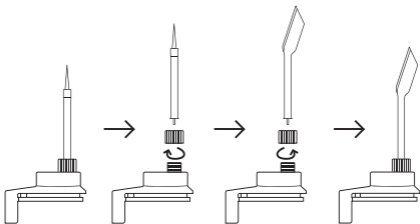

6. **FITTING AND REPLACING
THE RESISTANCE WIRE FOR
THE CUTTING EXTENSION:**

For proper replacement refer to Figure No. 10.

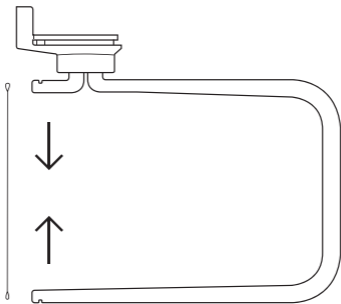

Maintenance

1. **3D DRAWING EXTENSION:**

A) Before inserting the string, always check that there is no dirt or deformed plastic on the string. If the tip or end is not smooth and flat, cut the distorted portion with scissors.

B) After using the 3Dsimo mini, always pull out the material and keep it in a resealable bag.

C) If the deformed wire slides inside 3Dsimo mini and it can't be pushed out by a newly inserted string, use the product in Figure No. 11, pushing the

6.

1. product into the bottom hole, which will cut the filament in half. Now you can insert and remove the deformed plastic.

D) If the nozzle is dirty, wipe with a paper towel. (! Beware hot!)

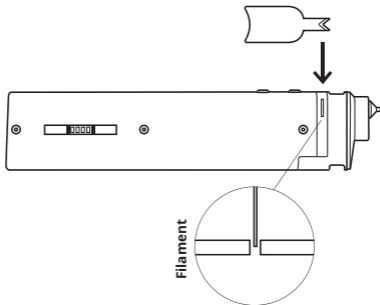

2. **SOLDERING AND BURNING**
EXTENSION:

A) When the tip is dirty, wipe with a paper towel.

B) Never try to get rid of dirt using a knife or sandpaper. This would damage the special coating for easy soldering.

C) When replacing the tip, always make sure to tighten all components (because of contact)

3. **CUTTING EXTENSION:**

A) When the wire is dirty, wipe with a paper towel.

B) If the wire breaks, always use new wire. (Always use original resistance wire from 3Dsimo!)

Warning

- A) Risk of burns. 3dsimo mini nozzle and tips reach high temperatures up to 480°C after heating. Do not touch the nozzle/tips or parts in their vicinity, or molten plastic, there is a risk of burns. Hot parts are shown in Figure No. 12.

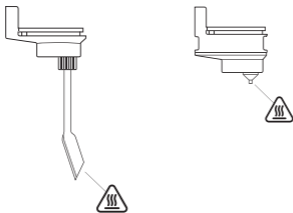

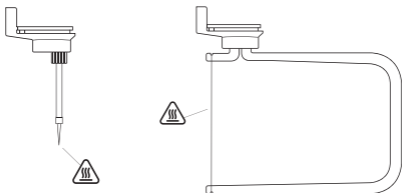

- B) Never remove the 3D drawing extender if no filament is inserted. Shown in Figure No. 13.

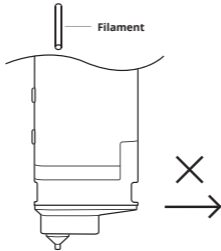

- C) Avoid contact of volatile and flammable substances with the hot nozzle/tip of the 3Dsimo mini. Inform those around you that the device is hot and should not be touched.
- D) Allow the nozzle/tip of the 3Dsimo to cool completely before storage. In the

- D) event of non-compliance, the carrying case can get damaged.

- E) Use only original material and accessories from our company. Otherwise, the 3Dsimo mini may get damaged due to poor quality or incorrect width. Other damage may be caused. The manufacturer is not liable for damage caused by the use of non-genuine material.

- F) Children may use the 3Dsimo only under parental supervision. This product is not a toy.

7.

- G) Keep the 3Dsimo dry during storage, transportation and operation as well as avoid contact with liquids.
- H) Do not disassemble the 3Dsimo mini power adapter. In the case of defects contact an authorized service center for assistance or repair.
- I) Do not use the AC adapter if the cord is damaged. Otherwise, you may cause electric shock or fire.
- J) Keep this information for future use.
- K) The manufacturer is not liable for damage caused using the device in conflict with this manual.

Specifications

ADAPTER:

Input voltage: 100 – 240V AC, 50Hz

Output power: 12W, Output voltage: 5V

3DSIMO MINI:

Input voltage 5V

NOISE LEVEL:

21 – 30 dB

Certifications

A) **RESTRICTION OF HAZARDOUS SUBSTANCES**

This device complies with the European Directive on Registration, Evaluation, Authorization and Restriction of Chemicals (REACH) (Directive No. 1907/2006/EC of the European Parliament and the European Council) and the European Directive on the Restriction of Use of Certain Hazardous Substances in Electrical and Electronic Equipment (RoHS) (Directive 2002/95/EC of the European Parliament and the European Council).

B) **COMPLIANCE WITH
EUROPEAN SAFETY
STANDARD**

This device complies with European safety directives.

Claims

A warranty of 12 months is provided for the equipment.

In the event of any defect or failure of the device, you can complain at:

Info@3dsimo.com.

The original material can be purchased here: www.3dsimo.com/e-shop

More information at

www.3dsimo.com